



Unit Model #: 37120908

Mower: Scag

Owner's Manual: Q0497

Mower Type: Liberty-Z

Engine Type: Kohler 7000 Series 24 HP

Deck Size: 52"

Vac Type: 9 Cu. Ft. Pro 2+ Bagger

Deck Type:

Drive Type: PTO-R Drive (3-Blade)

Revision:

Fits Year(s): 2015-Newer

A2192 Vac Kit

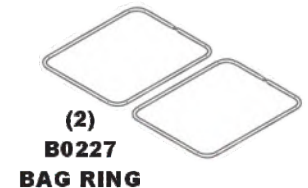
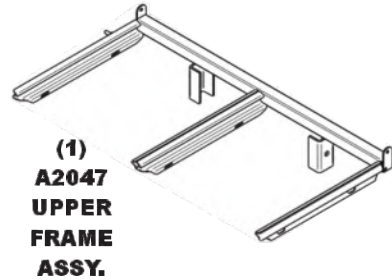
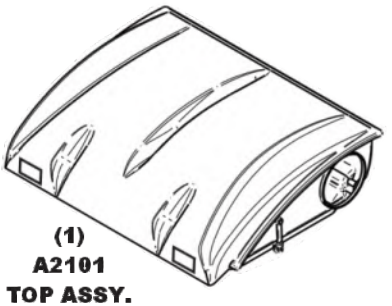

A1151 52" BAFFLE KIT



A2029 Mount Kit

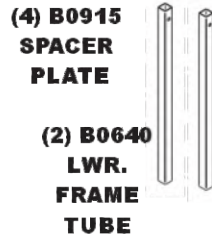
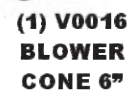
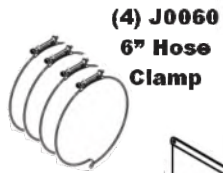
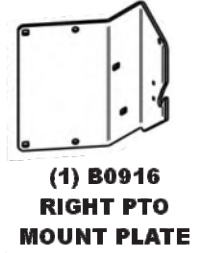
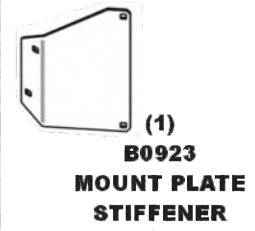

A1796 Boot Kit

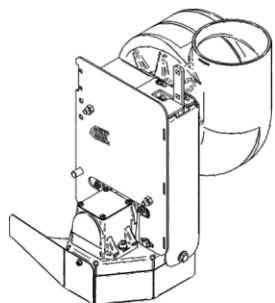
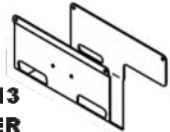
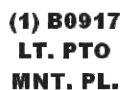
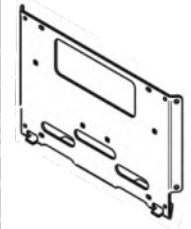
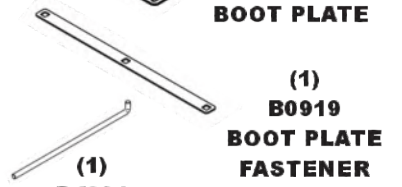

A1791 Weight Kit

